

SlimBox Drop Terminal Installation Instructions

Contents	Page #
Introduction and Product Overview	2
Installation Kits	3
Tools and additional materials needed for assembly	3
Product Photos and Item Identification	4
Product Mounting	5
Opening the Terminal	6
Closing the Terminal.....	8
Installing the Main Cable.....	9
Installing the Connector Tray.....	11
Installing the Drop Cables.....	13

Introduction

This document describes the assembly instructions for the SlimBox™ Drop Terminal, a fully re-enterable drop cable enclosure for aerial strand, pole, or wall mounting in the outside plant.

The terminal is available with multiple packaging options including adapters only and with pigtails.

Product Overview

Terminal Dimensions and Specifications

Terminal Dimensions	22.2 cm (8.75 in) wide X 29.8 cm (11.73 in) high X 11.7 cm (4.61 in) deep
Operating Temperature	-40° C to 85° C
Storage Temperature	-40° C to 85° C
Operating environment	Above ground only – Strand, pole or wall mounted

Material	UV Stabilized Polypropylene
Cable Ports	2 main cable ports, 16 drop cable ports
Maximum splice capacity when used as a splice closure	64



SlimBox Drop Terminal

Note: The Drop Terminal is not specified for underground applications.

Cable specifications

Drop cable capacity	16
Main cable Outer Diameter range	10-18 mm (0.39-0.71 in)
Round drop cable Outer Diameter range	4-5 mm
Flat drop cable dimensions	4.3 x 7.8 mm (0.16 x .31 in) (1,2,4, 6, and 12 fibers)

The SlimBox™ Drop Terminal basic module comes with a single splice tray. Optional installation kits such as connector tray, round grip and grommets, flat grip and grommets can be added to this basic module for additional capability.

Installation Kits

301091021	SLIMBOX, DROP TERMINAL - EMPTY	Drop Terminal includes one splice tray and solid grip and grommets
301092599	SLIMBOX, DROP TERMINAL-CONN TRAY KIT WITH 16 SC APC ADAPTERS	Kit required to install connectorized drops
301091039	SLIMBOX, DROP TERMINAL-SPLICE TRAY KIT	1 splice tray kit (16 splices per tray).
301091054	SLIMBOX, DROP TERMINAL-FLAT GRIP/GROMMET	Kit required to install FLAT drops, (1 Kit for installing 16 drops)
301091062	SLIMBOX, DROP TERMINAL-ROUND GRIP/GROMMET	Kit required to install round drops 4.5~5mm in diameter (1 Kit for installing 16 drops)
301113379	SLIMBOX, DROP TERMINAL-7MM GRIP/GROMMET	Kit required to install round drops 7mm in diameter (1 Kit for installing 16 drops)
3010091047	SLIMBOX, DROP TERMINAL-STRAND MOUNT HRDW	Kit required to strand mount enclosure.
301091070	SLIMBOX, DROP TERMINAL-W/4 SPLICE TRAYS	Includes drop terminal and 4 trays – 16 splices per tray – 64 single fusion splices
301091104	SLIMBOX, DROP TERMINAL- 1 SPLICE TRAY W/POLE BRACKET	Includes drop terminal and 1 tray, flat and round cable clamps

Ordering example 1:

SlimBox drop terminal used to mid-span splice a main cable to flat drop cables, mounted on a pole - Order 30109021, 301091054

Ordering example 2:

SlimBox drop terminal as a splice closure, pole mounted, up to 64 splices - Order 30109070

Ordering example 3:

SlimBox drop terminal used as a terminal to connect pigtails spliced to a main cable with pre-connectorized round drop cables, mounted on strand - Order 301091021, 301095299, 301091062, 3010091047

Tools needed for assembly

- Cable preparation tools
- Tube splitter
- Flat and Phillips-head screwdrivers

Materials needed for assembly (not included) and not included

Mastic sealing tape
Splice sleeves – OFS model S922-40 40 mm recommended

Product Photos and Item Identification



Strand Mount Kit

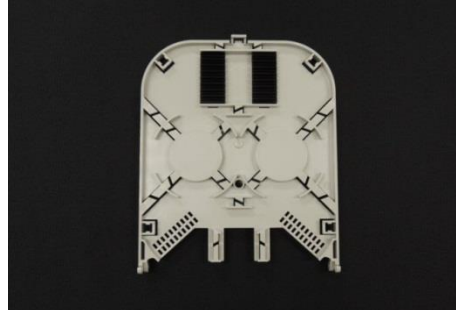

Splice Tray

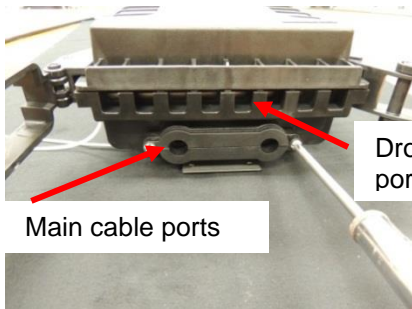

Main cable ports

Drop cable ports

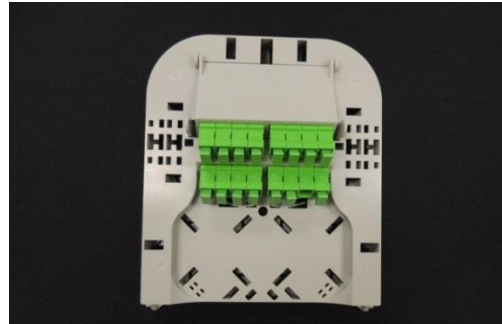

Connector Tray

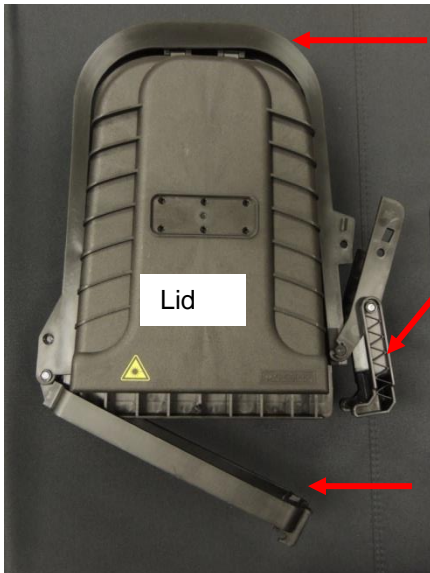

Closing Device

Lid

Hook

Split clamp part of closing device

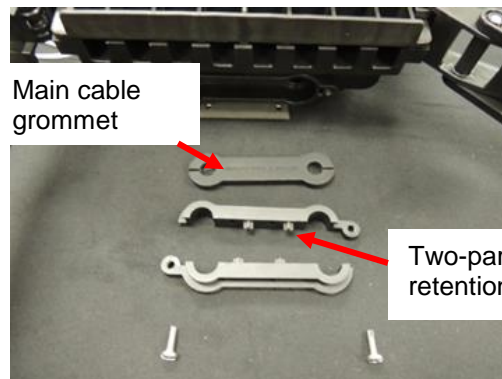

Main cable grommet

Two-part Grommet retention plate



Flat drop cable grommets



Round drop cable grommets

Product Mounting

1. Pole Mounting – Place the drop terminal in position, with the drop ports facing the ground. Using the correct clamp (purchased locally) for the specific pole, place the clamp through the bracket on the back of the terminal. Secure the clamp to the pole.



2. Wall Mounting – Remove the bracket from the back of the terminal and attach it to the wall. Then re-attach the terminal to the bracket with the screws on the side.

Remove this bracket, attach to the wall, then reattach SlimBox to the bracket

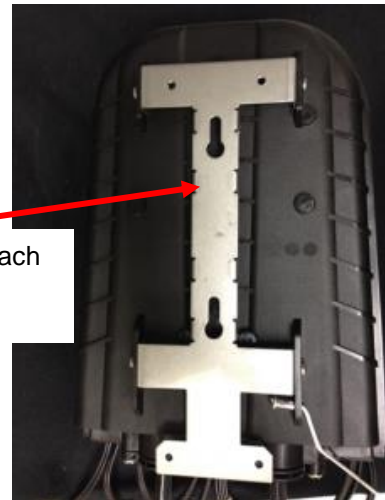

THE PRODUCT CAN NOT BE MOUNTED IN THE HORIZONTAL POSITION

Opening the Terminal (with or without drops installed in the terminal)

1. Unfasten the clamp bracket from the side of the Drop Terminal, by pulling the tab upward, then to the right and down.

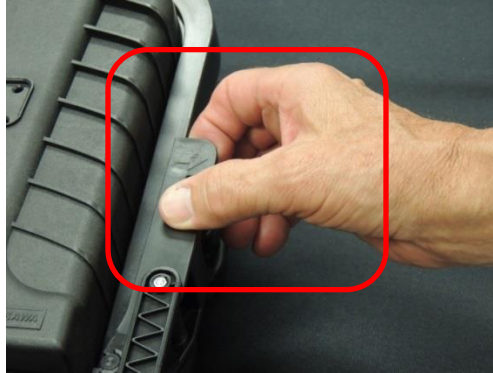

2. Unfasten the hook from the side bracket. A slight upward tap to the split clamp will release it from the locking bracket



3. Twist the split clamp downwards and slightly open the bracket to allow the drops to slide through the bracket.

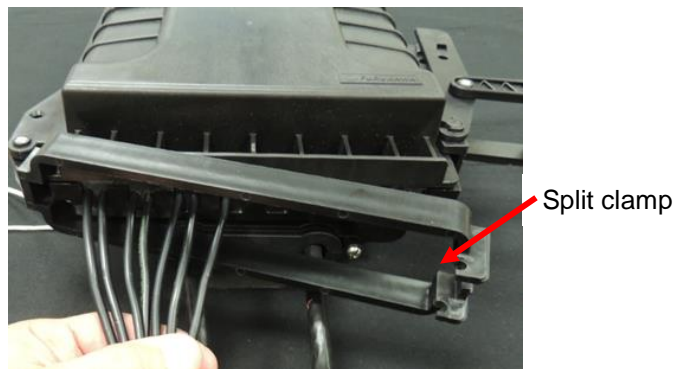

4. Pull the closing device outward on both ends, then upwards to release it from the terminal. This enables the lid to be pulled away from the base. Pull the lid away from the base.



Pulling closing device upward

5. Attach the lid support bar at the desired height providing room to work on the splice tray or the connector tray.

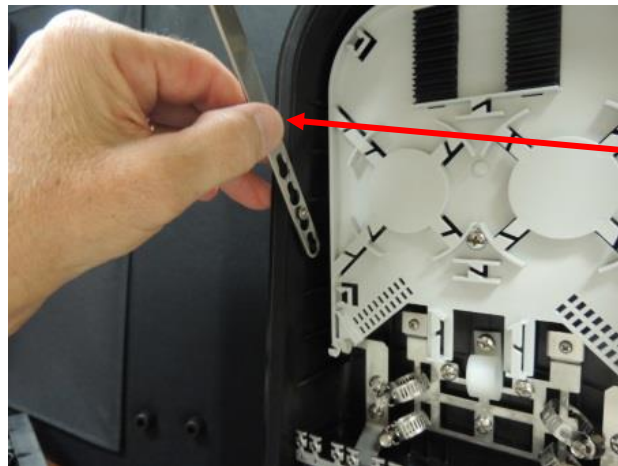

Lid support bar

Closing the terminal – Reverse the process of opening the terminal

1. Detach the lid support bar. Align the cover with the base



2. Slide the closing device down over the lid and base. Move the closing device back across the bottom, opening the split clamp to allow the drop assemblies to pass through the split clamp; similar to removing the device. Mount the axle onto the hooks of the split part.



3. Snap the latch to the side of the base.



Installing the Main Cable

1. The main cables are mounted in the rear of the base. To access the main cable grommets, remove the screws on either side of the cable ports. Remove the two sides of the main cable grommet retention plate and main cable grommet. Cut the ends of the main cable grommet, as shown below, to allow the cable to be placed in the main cable grommet.

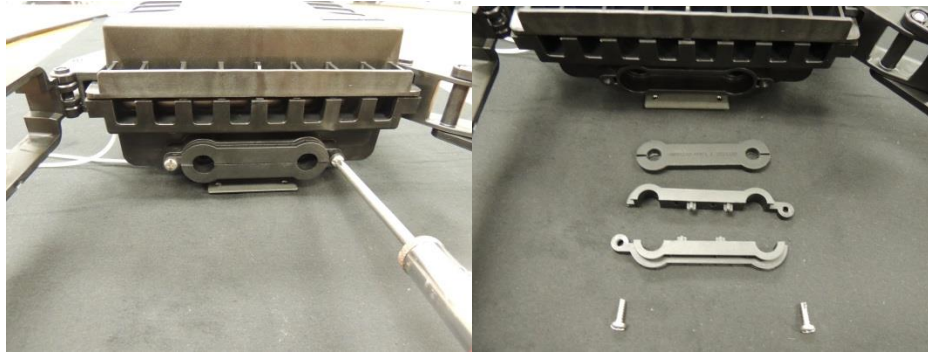

2. Prepare the cable by prepping the cable either for mid-span splicing or to splice cable ends. See OFS Installation Practice IP-011A, “*Sheath Removal and Mid-Span Access, for Single Jacket, Option1™, and AccuTube™, Loose Tube Optical Fiber Cables*” for detailed instructions on how to prepare the cable for splicing. For mid span splicing, target having approximately 178 cm (70 in) of buffer tube to be coiled in the back of the closure.
3. To prep the cable for mid-span splicing, remove 180 cm (72 in) of the jacket. Separate the aramid yarn from the buffer tubes. Cut and remove the aramid yarn. Leave approximately 5 cm (2 in) of FRP exposed to be attached to the screw clamp inside the closure. Apply 2 wraps of mastic sealing tape to the outside of the cable 5 cm (2 in) below where the cable jacket ends.



Cable with 178 cm (70 in) of jacket removed for mid-span splicing



Leave approximately 5 cm (2 in) of FRP exposed to attach to the screw clamp inside the closure

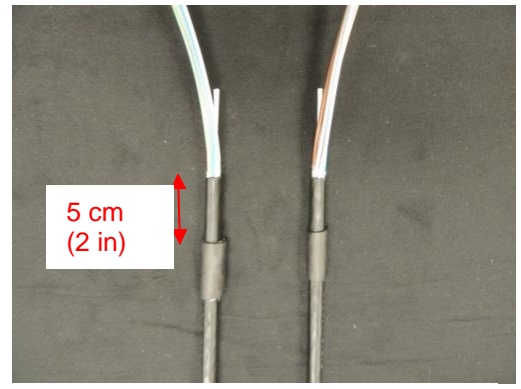

Apply 2 wraps of mastic sealing tape to the cable 5 cm (2 in) from the cable jacket end.

4. Remove the splice tray from the base of the closure by removing the screw from the center of the tray and release the two attached corners of the tray. Open the cable clamps in the base of the terminal. Route the tubes in the base of the enclosure. Open the cable clamps in the base of the terminal. Slide the cable through the entry ports and the cable clamps being careful not to bend the tubes.

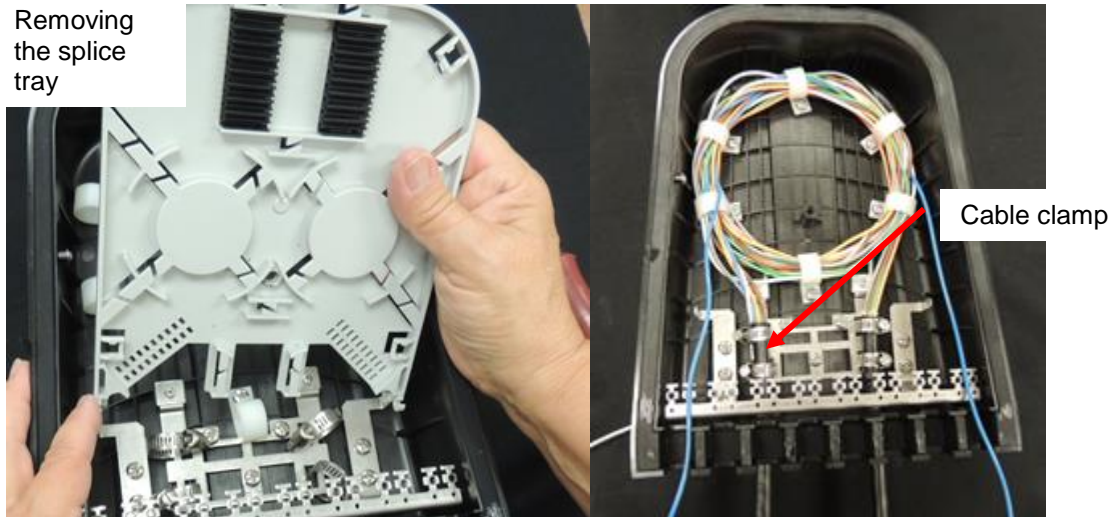

5. Use the screw clamp to clamp the FRP in place, as shown in the picture below.

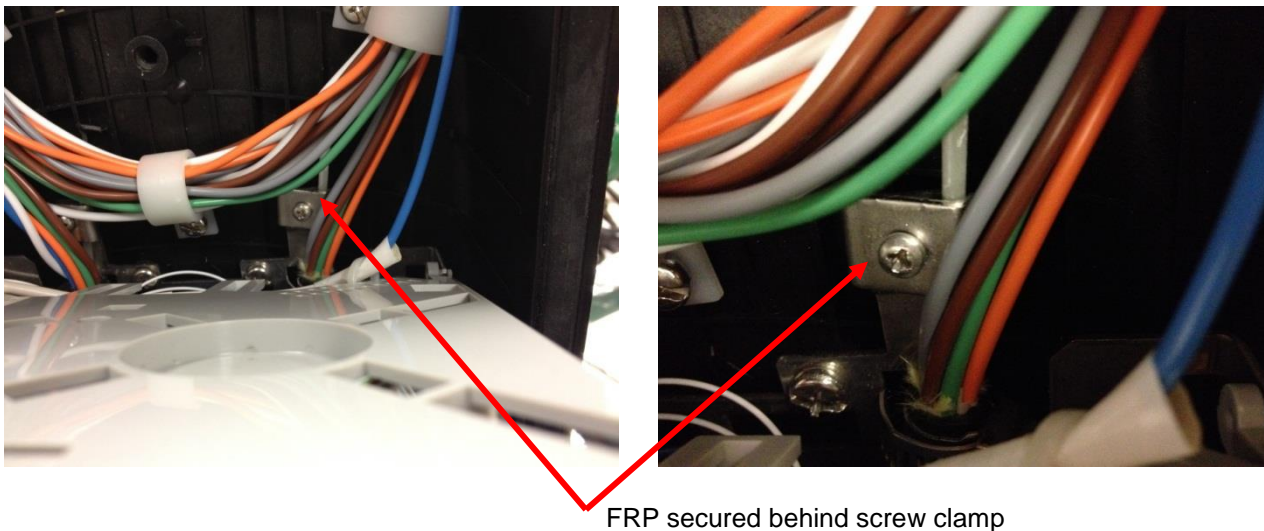

6. Place the grommets and prepared cable (with the mastic tape) into the entry clamp and place in the base of the enclosure. Screw the entry clamp back into place. Mark and cut the tube with the fiber to be spliced and route it to the top prior to attaching the splice tray back in position.

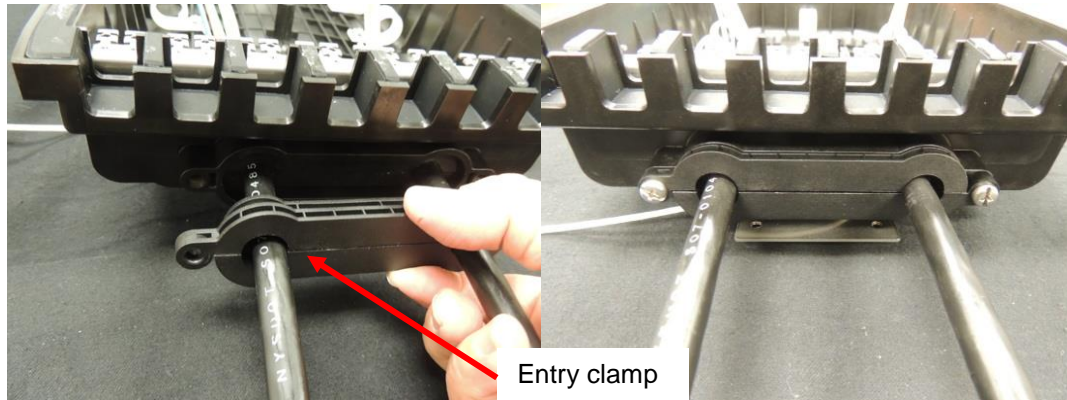

7. Prepare the fibers according to local practice. Tubes from the right should enter the tray from the left and tubes from the left should enter the tray from the right. Splice the required number of fibers. If splicing into a splitter, it is best to wait for the attachment of the connector tray before completing the splitter splicing.

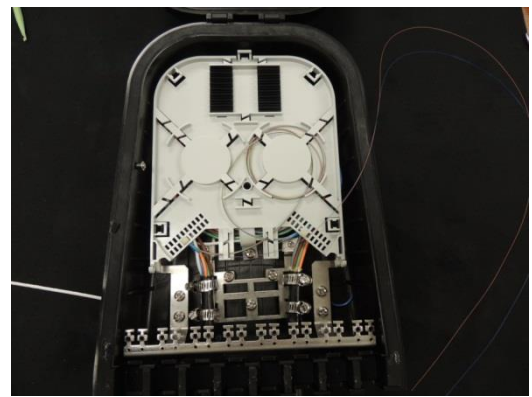

Installing the Connector Tray

1. If the adapters did not come with the connector tray install the adapters making sure that the key slot is in the same position for each adapter.

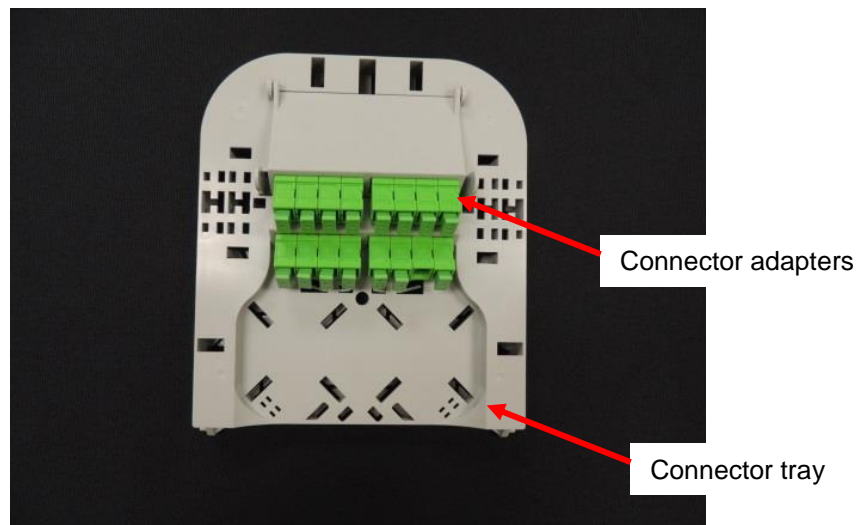

2. Place the connector tray in the base of the drop terminal

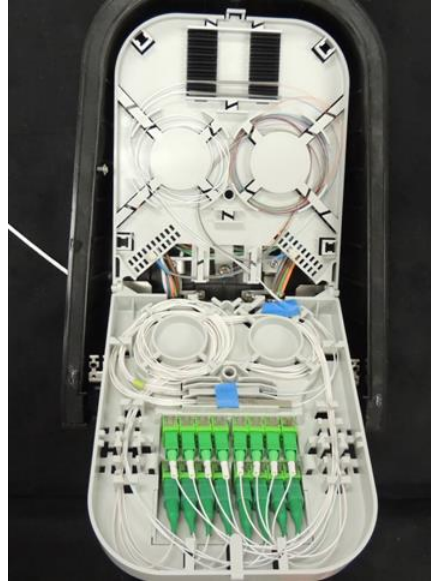

3. If using a splitter place the splitter in the rear of the tray, attaching the connectorized end on the back of the connector tray. Route the feeder or input fiber to the splice tray and splice to the designated fiber. Once splicing and splitter placement is complete close the connector tray and install the set screw.

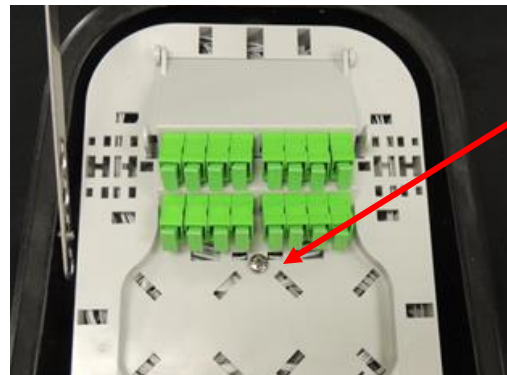
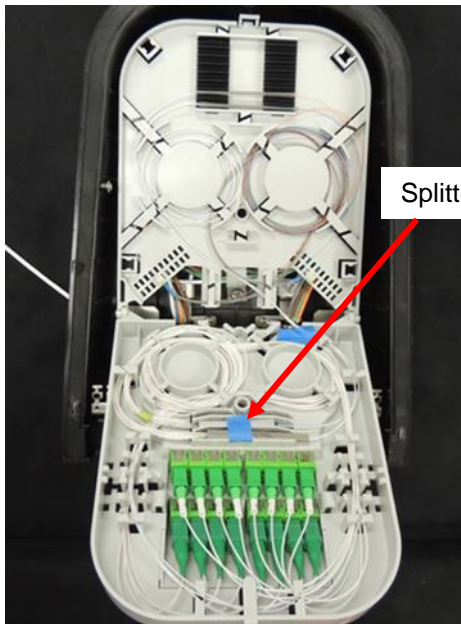

4. The drop terminal is ready for installation of the drop assemblies.

Installing the Drop Assemblies

1. Determine the correct grip and grommets needed for the chosen drop cable or assembly. There are five types, round grommets (3.0, 4.8 and 7.0 mm); and flat grommets (low friction and TB flat drop).



Round drop grommets



Flat drop grommets

2. Attach the grips in place with screws

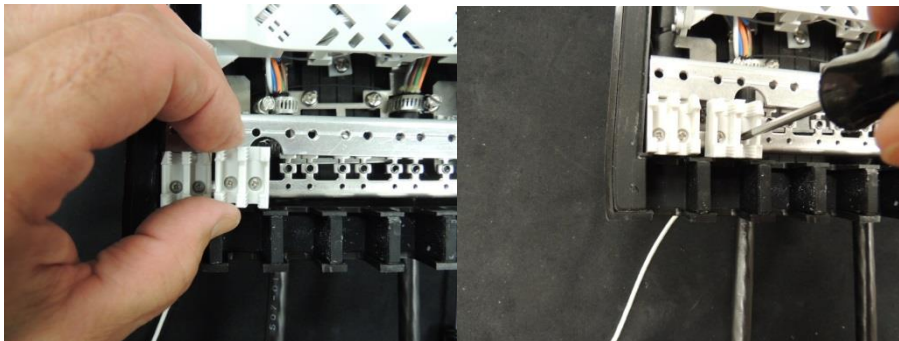

3. Attach the tie down bracket to the base if not already installed.

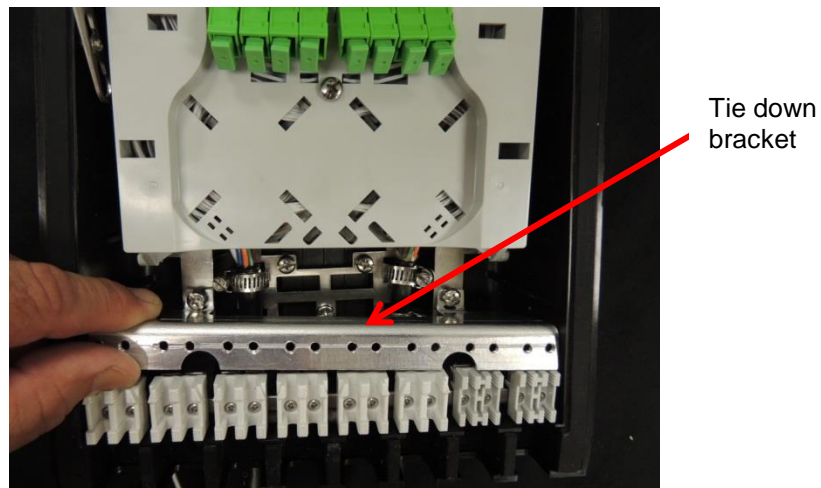

- Slide the grommets that will not be used at this time into the slots.
- For the grommets that will be used to hold the drop assemblies pull the grommet apart and slide the drop into the split.

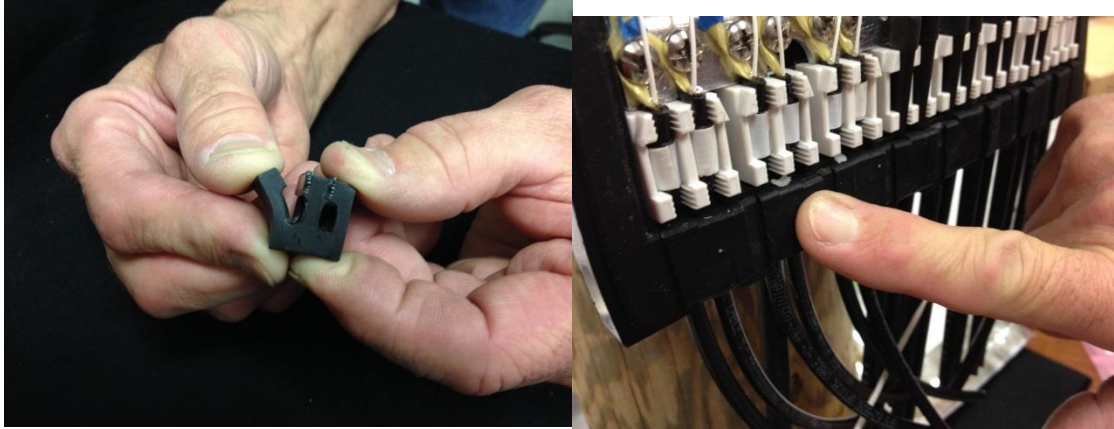

- Slide the grommet into the base pushing the grommet until it is flush with the base slot.

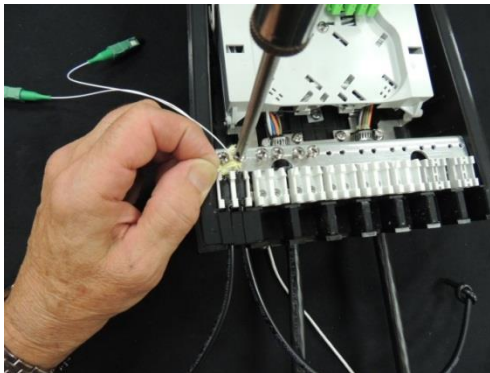

- If utilizing round drops, attach the exposed aramid yarn to the tie down bracket.

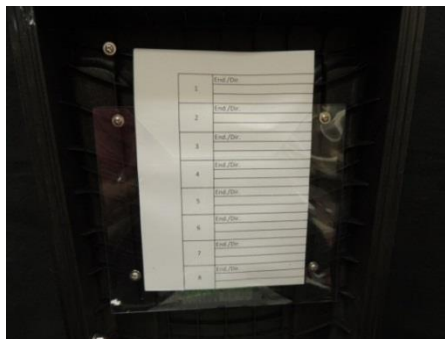

- Record the connection according to company policy in the document and then place in the inside cover prior to closing the drop terminal
- Close the terminal as shown in the “Closing the Terminal” section of this instruction document.